

SURPLUSTRADERS.NET

PO Box 276
Alburg, VT 05440

Website: www.surplustraders.net
Email: sales@surplustraders.net

Tel: 800-341-6468
Fax: 888-661-3032

This spec sheet is provided courtesy of Surplustraders.net

If you are looking for brand names, model numbers or other products that are not currently represented in this spec sheet, please, give us a call or send us an email with your requirements so we can further discuss your needs.

Thank you

Ph: 866-831-8848

Fax: 888-661-3032

Email: sales@surplustraders.net

Website: www.surplustraders.net

Model 15T Thru-Bore Model 15H Hollow Bore

Incremental Thru-Bore & Motor Mount Encoders



Features

- Very High Performance Economical Encoder
- Low Profile 1.0" (25.4 mm) Height and 1.5" (38 mm) Diameter
- Thru-Bore (sizes up to 0.375" or 10 mm)
- Simple, Innovative Flex Mounting System (Global Mounting Standards)
- Up To 12 Pole Commutation Optional (for brushless motor control)

The Model 15T or 15H offers a high performance feedback solution in a low profile package. Unlike modular or kit encoders, the Model 15 utilizes an integral bearing set, and an innovative flexible mounting system which is much more tolerant to axial misalignment or radial shaft run-out. The slotted flex mounts provide 20 or 30 degrees of rotational adjustment for commutation or index pulse timing. Installation is quick and easy! For brushless servo motor applications, three 120° electrical phase tracks can provide up to 12 pole commutation feedback. The optional 100° C and 120° C temperature options allow servo motors to operate at higher power outputs and duty cycles. The Model 15 provides stable and reliable operation and is an excellent replacement for other manufacturers modular encoders where a high performance solution is desired.

Common Applications

Servo Motor Control, Robotics, Specialty Assembly Machines, Digital Plotters, High Power Motors

Model 15T/H Ordering Guide

Blue type indicates price adder options. Not all configuration combinations may be available. Contact Customer Service for details.

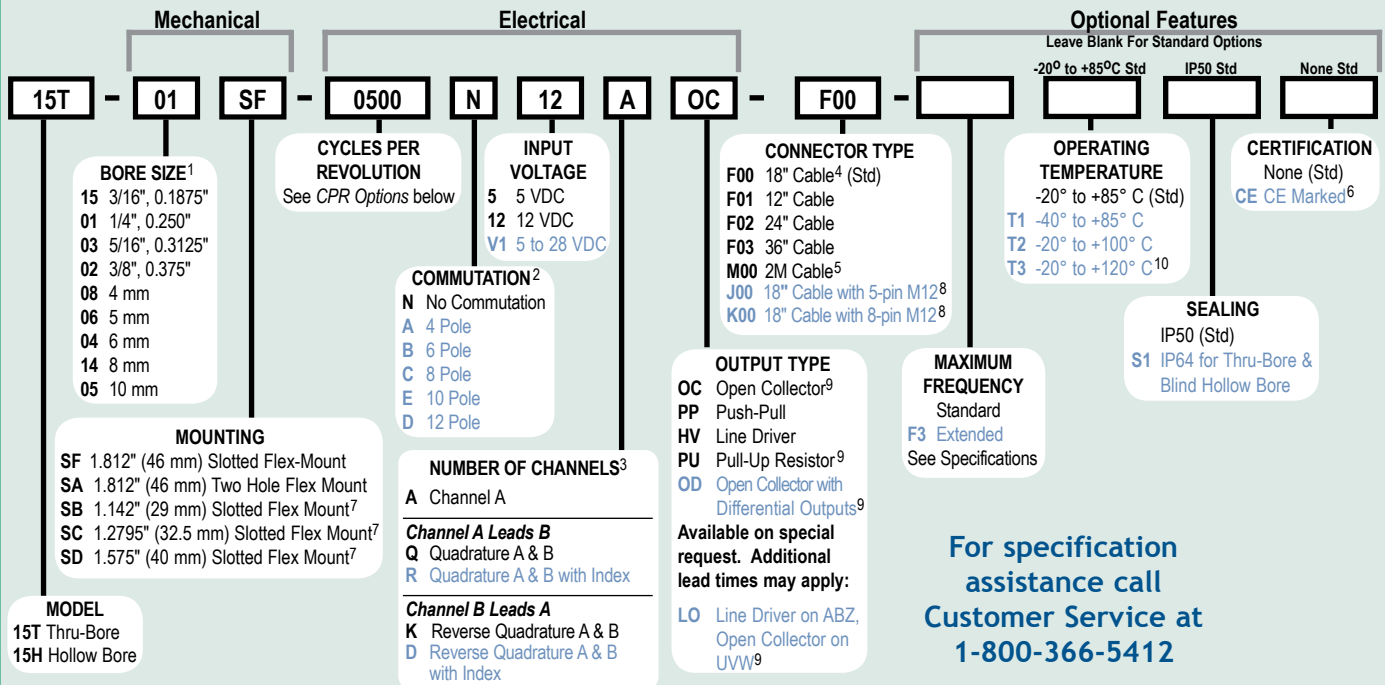

For specification assistance call
Customer Service at
1-800-366-5412

Model 15T/H CPR Options

0001 thru 0189*	0198	0200	0250
0256	0300	0315	0360
0400	0450	0500	0550
0600	0650	0700	0750
0800	1000	1024	1125
1200	1250	1500+	1800
2000+	2048	2500	2540
3000+	3600+	4000+	4096+
5000+	6000+	7200	8192+
10,000+			

*Not available in 12V option

New CPR values are periodically added to those listed. Contact Customer Service to determine all currently available values. Special disk resolutions are available upon request and may be subject to a one-time NRE fee.

NOTES:

- 1 Contact Customer Service for additional options not shown.
- 2 Not available in all configurations, and not available with V1 Input Voltage. Contact Customer Service for availability.
- 3 Contact Customer Service for non-standard index gating or phase relationship options.
- 4 For non-standard English cable lengths enter 'F' plus cable length expressed in feet. Example: F06 = 6 feet of cable. Frequency above 300 kHz standard cable lengths only.
- 5 For non-standard metric cable lengths enter 'M' plus cable length expressed in meters. Example: M06 = 6 meters of cable.
- 6 Please refer to **Technical Bulletin TB100: When to Choose the CE Option** at www.encoder.com.
- 7 This mount requires button head screws and a modified Hex wrench. Order appropriate Installation Kit listed under Specifications.
- 8 Not available with commutation. 5-pin not available with Line Driver (HV, OD, LO) outputs. Additional cable lengths available. Please consult Customer Service.
- 9 With Input Voltage above 16 VDC, operating temperature is limited to 85° C.
- 10 Only available with 5 VDC Input Voltage.

Model 15T Thru-Bore Model 15H Hollow Bore

Model 15T/H Specifications

Electrical

Input Voltage	5 VDC ±10% Fixed Voltage 12 VDC ±10% Fixed Voltage 4.75 to 28 VDC max for temperatures up to 85° C 4.75 to 24 VDC for temperatures between 85° to 100° C
Input Current	100 mA max (65 mA typical) with no output load
Output Format	Incremental- Two square waves in quadrature with channel A leading B for clockwise shaft rotation, as viewed from the encoder mounting face. See <i>Waveform Diagrams</i> .
Output Types	Open Collector- 20 mA max per channel Push-Pull- 20 mA max per channel Pull-Up- Open collector with 2.2K ohm Pull-Up 20 mA max per channel Line Driver- 20 mA max per channel (Meets RS 422 at 5 VDC supply)
Index	Once per revolution. 190 to 10,000 CPR: Gated to output A 1 to 189 CPR: Ungated See <i>Waveform Diagrams</i> .
Max. Frequency	Standard Frequency Response is 200 kHz for CPR 1 to 2540 500 kHz for CPR 2541 to 5000 1 MHz for CPR 5001 to 10,000 Extended Frequency Response (optional) is 300 kHz for CPR 2000, 2048, 2500, and 2540
Noise Immunity	Tested to BS EN61000-6-2; BS EN50081-2; BS EN61000-4-2; BS EN61000-4-3; BS EN61000-4-6; BS EN500811
Symmetry	180° (±18°) electrical
Quad. Phasing	90° (±22.5°) electrical
Min. Edge Sep	67.5° electrical
Accuracy	Within 0.017° mechanical or 1 arc-minute from true position. (for CPR>189)
Commutation	Up to 12 pole. Contact Customer Service for availability.
Comm. Accuracy	1° mechanical

Mechanical

Max Shaft Speed	8000 RPM. Higher speeds may be achievable, contact Customer Service.
Bore Size	0.1875" through 0.375", 5 mm through 10 mm
Bore Tolerance	-0.0000" / +0.0006"
User Shaft Tolerances	
Radial Runout	0.008" max
Axial Endplay	±0.030" max
Starting Torque	IP50 Hollow Bore: 0.2 oz-in IP50 Thru-Bore: 0.3 oz-in IP64: 0.6 oz-in
Moment of Inertia	6.7 x 10 ⁻⁹ oz-in-sec ² (4.8 gm-cm ²)
Max Acceleration	1 x 10 ⁹ rad/sec ²
Electrical Conn	18" cable (foil and braid shield, 24 AWG conductors non-commutated, 28 AWG commutated), 5- or 8-pin M12 (12 mm) in-line connector with 18" cable (braid shield)
Mounting	1.812" (46 mm) Slotted Flex mount 1.812" (46 mm) Two Hole Flex Mount 1.142" (29 mm) Slotted Flex Mount 1.2795" (32.5 mm) Slotted Flex Mount 1.575" (40 mm) Slotted Flex Mount (See mechanical drawings for dimensions)
Weight	3 oz typical

Environmental

Operating Temp	-20° to +85° C standard models -40° to +85° C for low temperature option -20° to +100° C for high temperature option -20° to +120° C for extreme temperature option
Storage Temp	-25° to +85° C
Humidity	98% RH non-condensing
Vibration	10 g @ 58 to 500 Hz
Shock	80 g @ 11 ms duration
Sealing	IP50 standard; IP64 available

Model 15T/H 1.811" (46 mm) Slotted Flex Mount (SF)

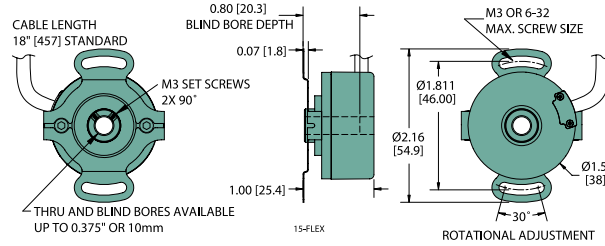

Model 15T/H 1.811" (46 mm) Two Hole Flex Mount (SA)

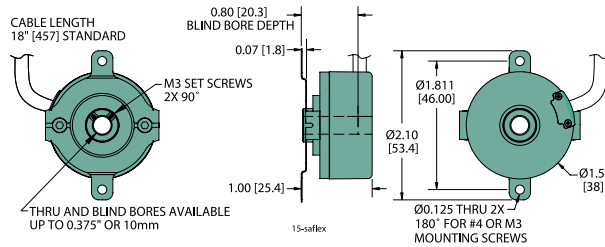

Model 15T/H Small Diameter Slotted Flex Mounts

1.142" (29 mm): SB*

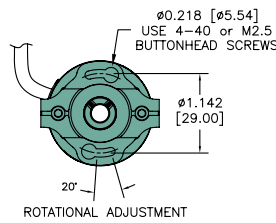

1.2795" (32.5 mm): SC*

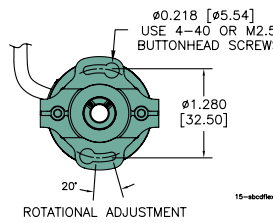

1.575" (40 mm): SD*

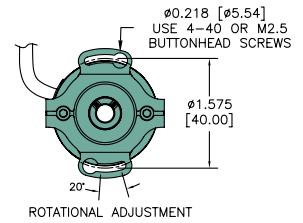

Encoder Length and Diameter are the same as SF and SA mounts detailed above
All dimensions are in inches with a tolerance of ±0.005" or ±0.01" unless otherwise specified
Metric dimensions are given in brackets [mm]

*** Order Appropriate No Charge Mounting and Installation Kit for SB, SC, or SD Option**

176150-01 Installation Kit, 4-40 Buttonhead Screws with 0.062" Shortened Hex Wrench

176149-01 Installation Kit, M 2.5 Buttonhead Screws with 1.5 mm Shortened Hex Wrench

Each kit contains 10 screws for mounting 5 encoders



"SB" Slotted Flex Mount

Waveform Diagrams

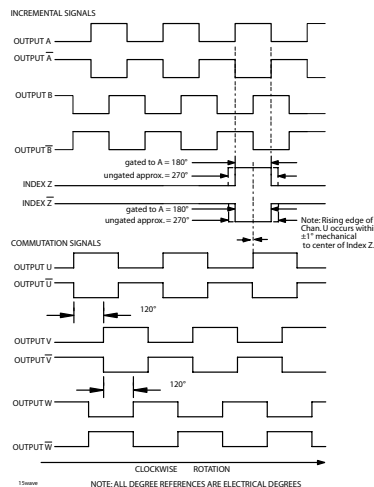

Wiring Table

Function	Cable Wire Color	5-pin M12**	8-pin M12**	
Com	Black	3	7	* CE Option: Cable shield (bare wire) is connected to internal case
+VDC	White	1	2	
A	Brown	4	1	**Non-CE Option: Cable shield is connected to M12 connector body.
A'	Yellow	--	3	
B	Red	2	4	CE Option: Cable shield and M12 connector body is connected to internal case.
B'	Green	--	5	
Z	Orange	5	6	
Z'	Blue	--	8	
U	Violet	--	--	
U'	Gray	--	--	
V	Pink	--	--	
V'	Tan	--	--	
W	Red/Green	--	--	
W'	Red/Yellow	--	--	
Shield	Bare *	--	--	

Incremental Thru-Bore & Motor Mount Encoders